

安装指导手册

单相 低压 离网逆变器 - Isuna 8000SO-12000SO

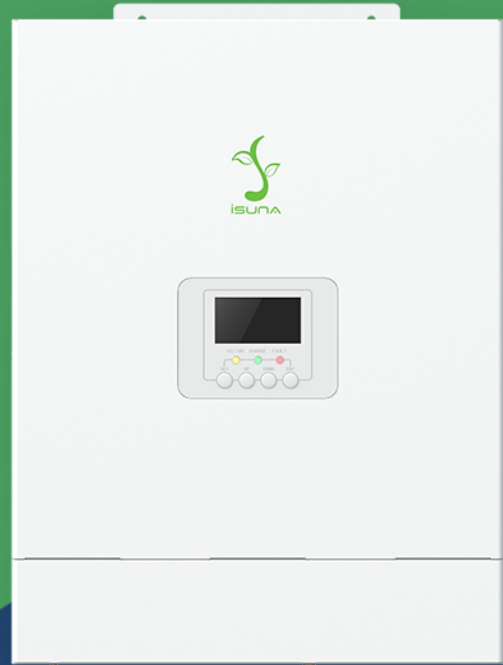

本指南仅适用于安装过程的指导说明
请在安装前仔细阅读用户手册

安装工具

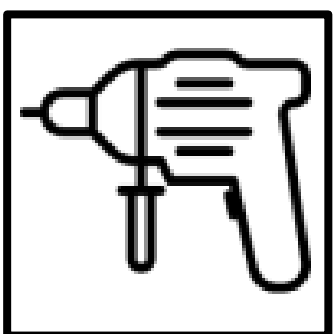

冲击钻：墙面打孔

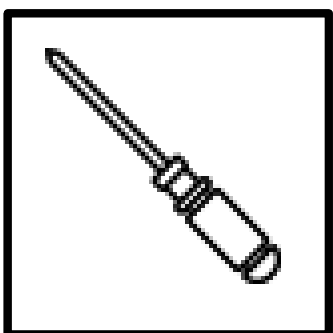

M6十字螺丝刀：拆卸、安装螺丝和接线

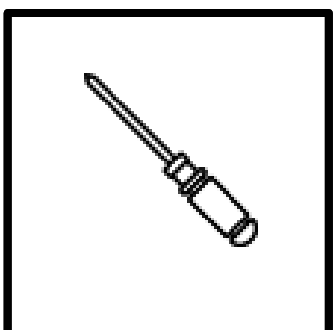

M4十字螺丝刀：拆卸、安装负载端子螺丝

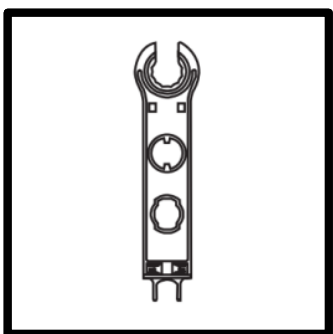

拆卸工具：拆卸PV、BAT线端端子

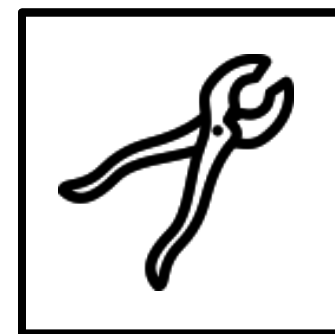

剥线钳：剥线

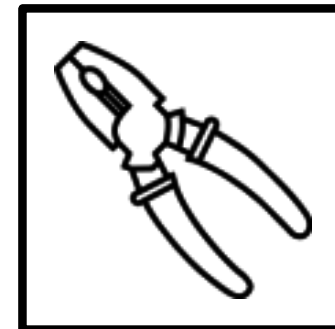

压线钳：压接PV、BAT电缆线

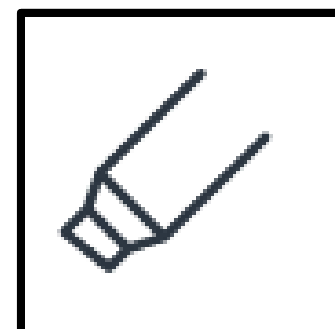

记号笔：打孔记号

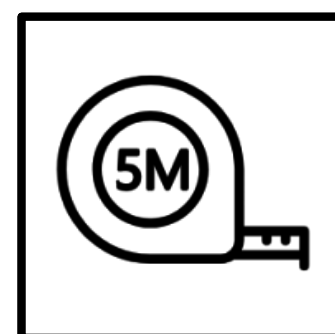

卷尺：测量距离

Installation of wall mounts and inverters

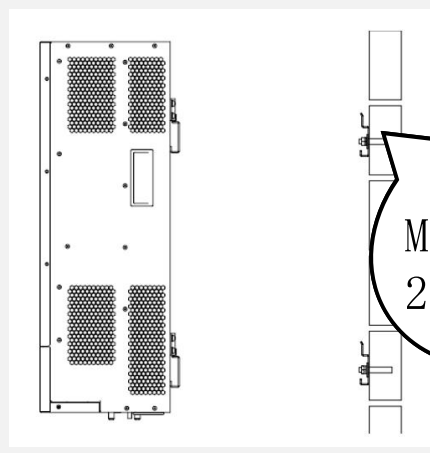
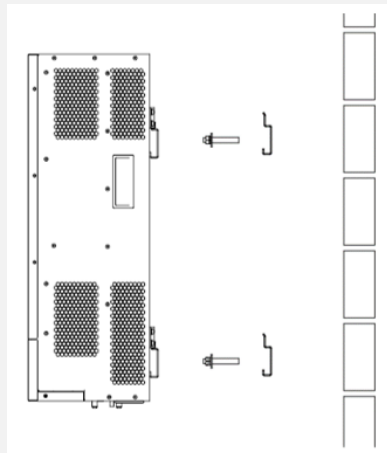

M8*80 2pcs
20N*m

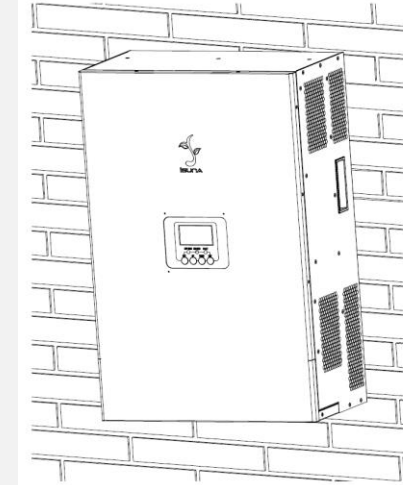
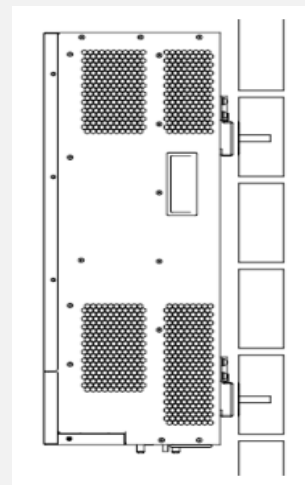

Electrical Connection Diagram

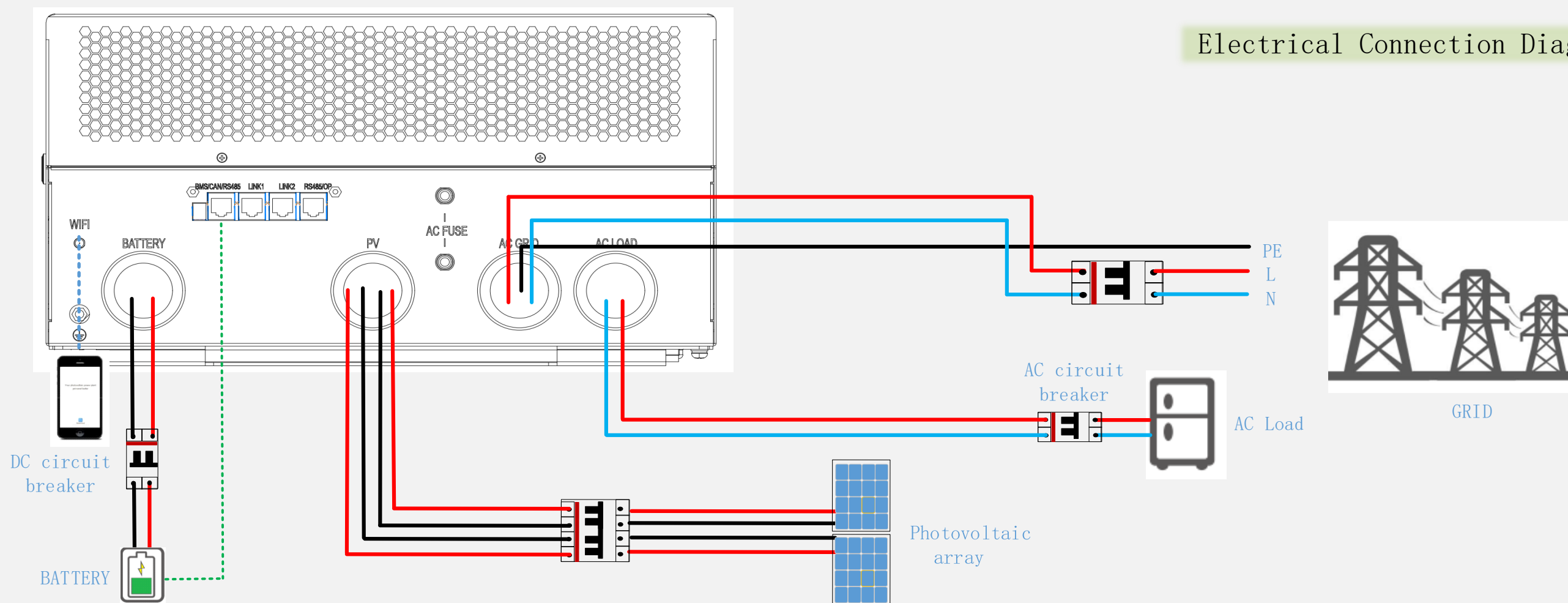

Inverter grounding

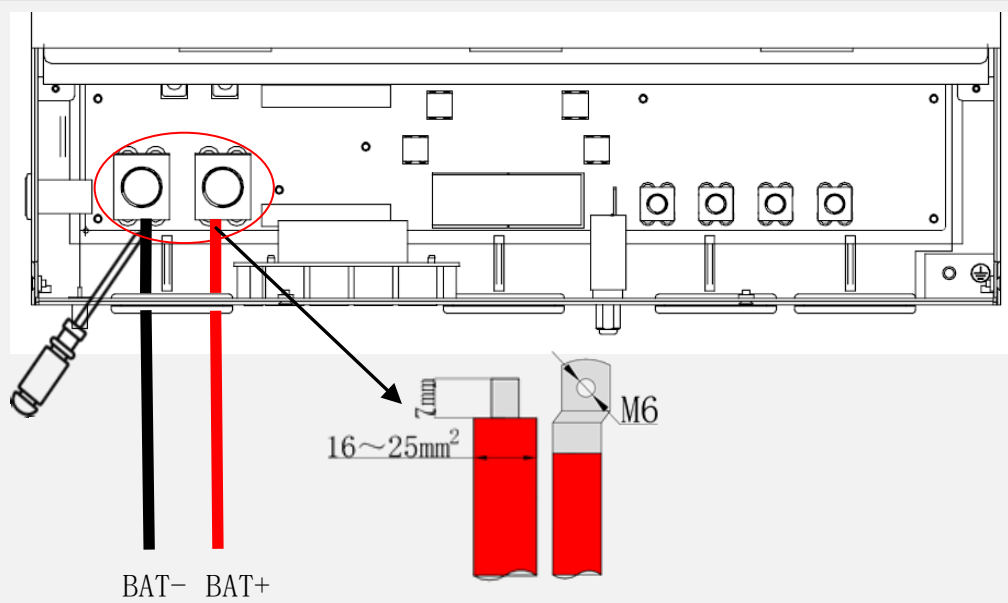
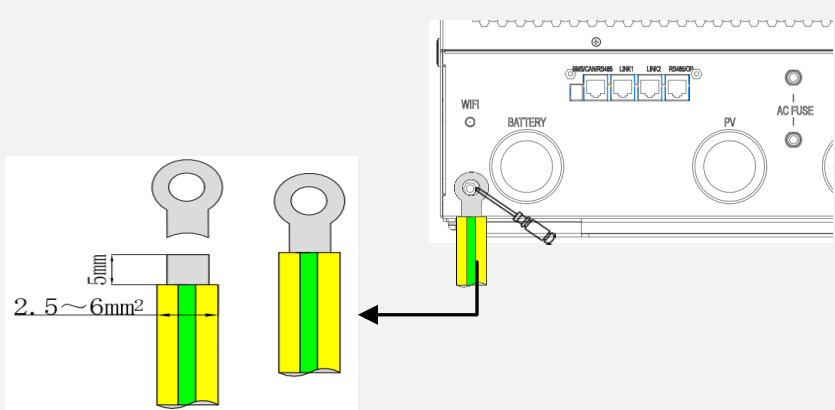

Connecting the battery

Avoid incorrect connection between positive and negative!!!

Connecting PV

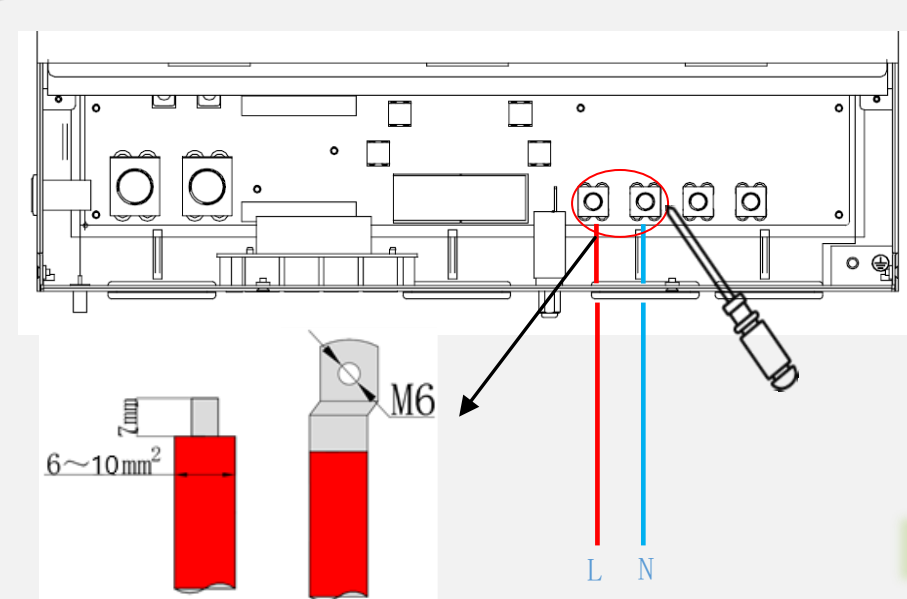
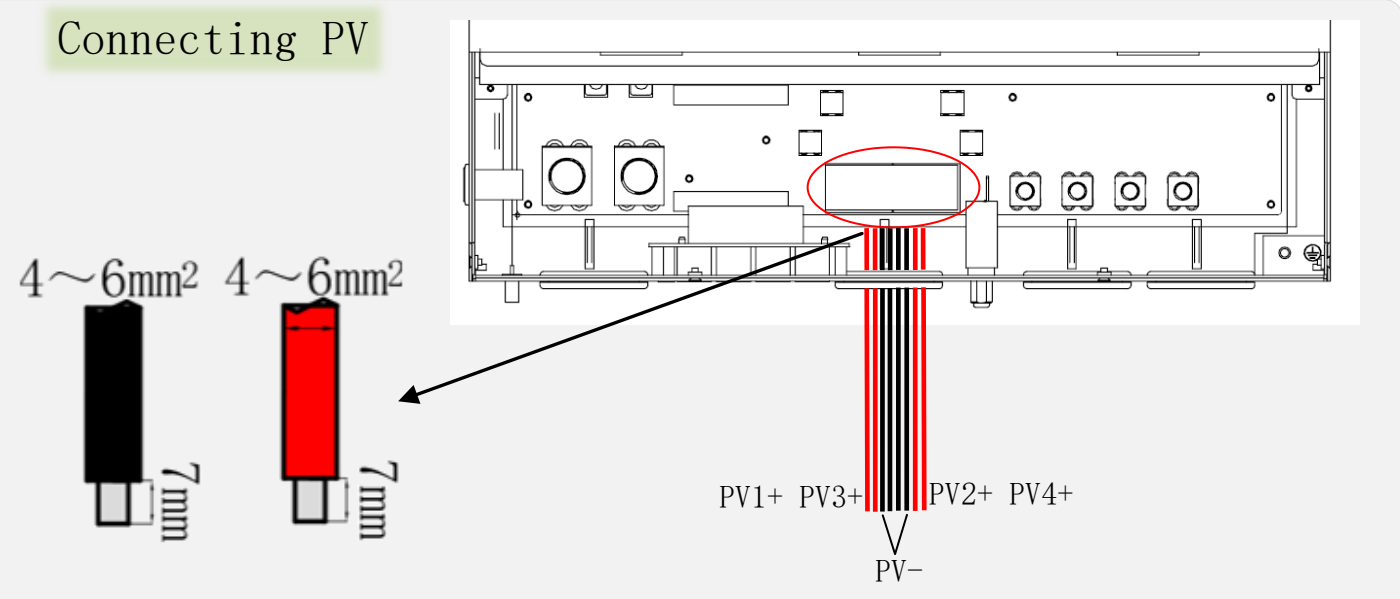

Connecting the GRID

Connecting the AC Load

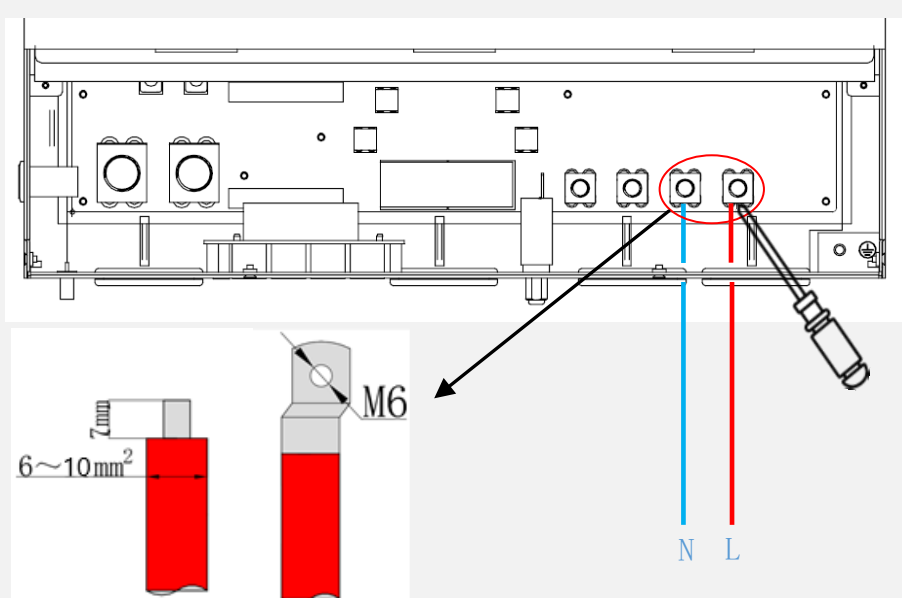

Connecting the Antenna

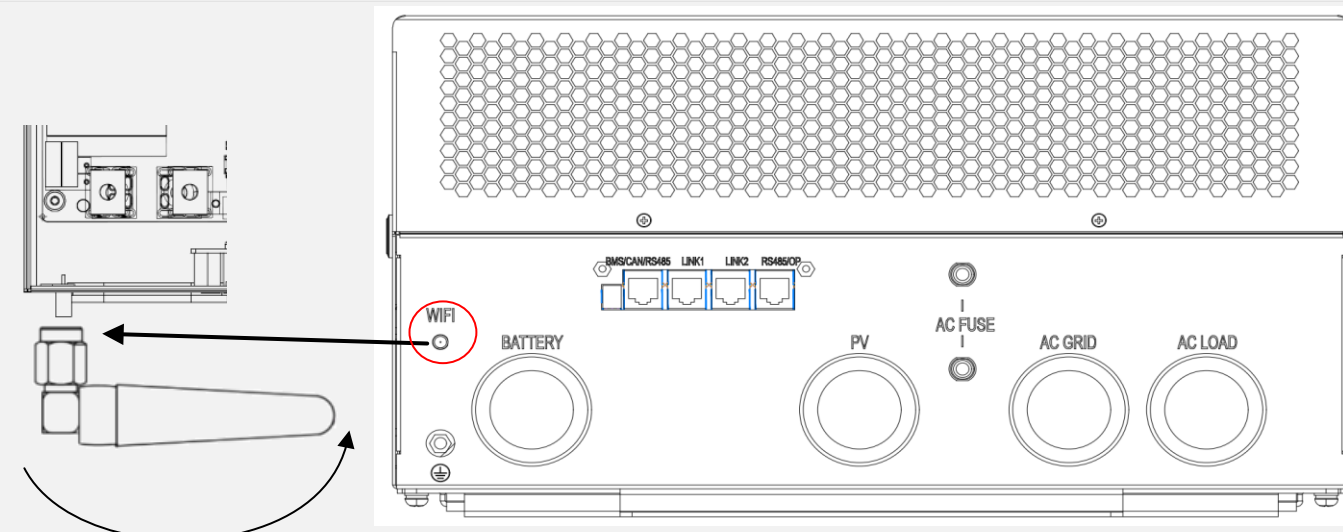

ESS Link Download



Android



Google play



iOS

Download the user manual for details:
www.sinexcel-isuna.com/Download/